

АРХИТЕКТОНСКО ПРОЕКТИРАЊЕ 1

лекција 13
01.03.2024

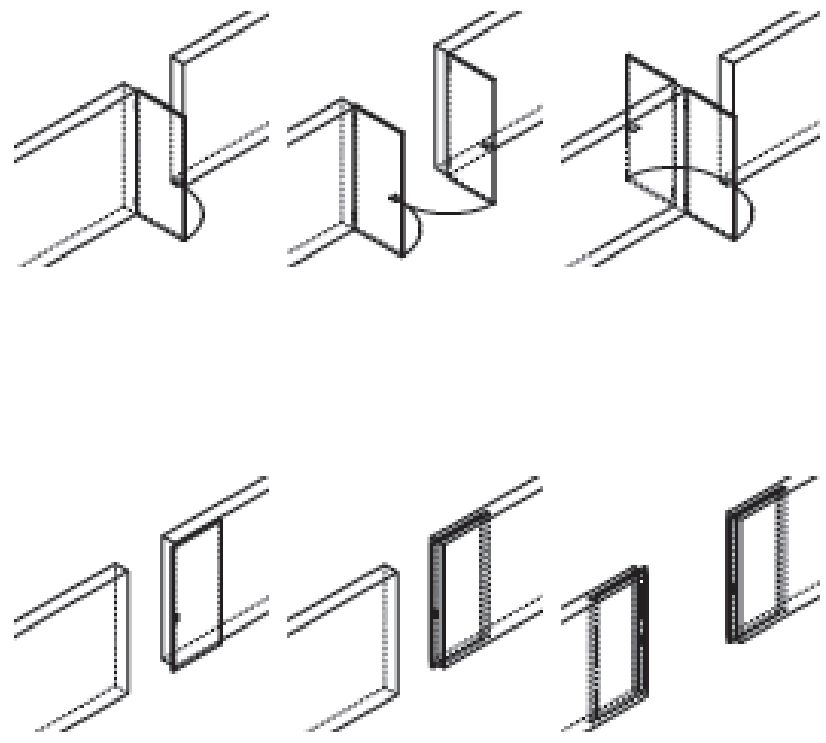
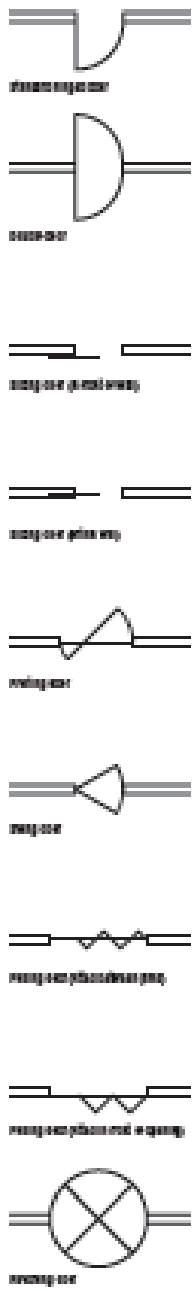

ОТВОРИ

ВРАТИ <

Видови на врати според начинот на отварање

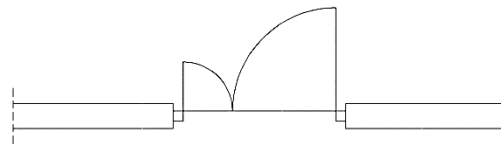
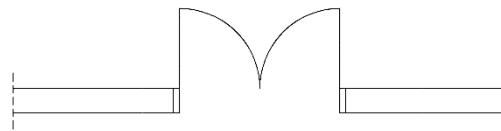
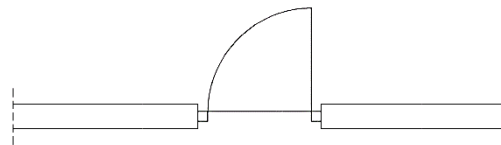
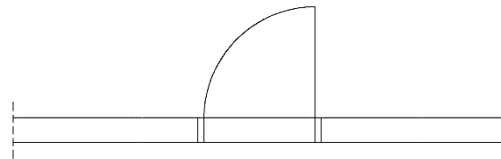
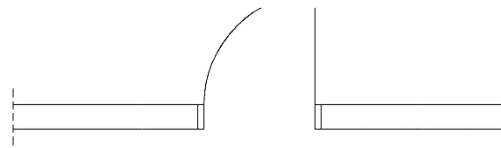
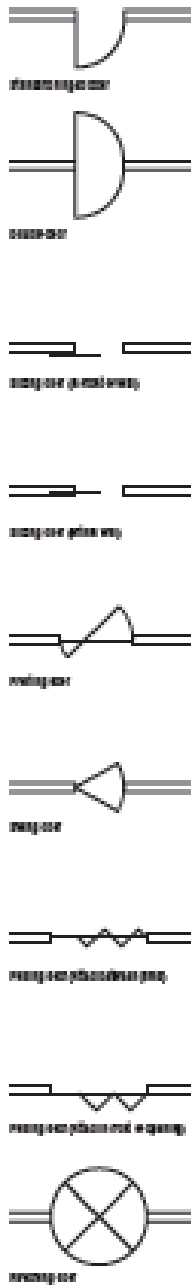

[M=1:50]

ОТВОРИ

ВРАТИ <

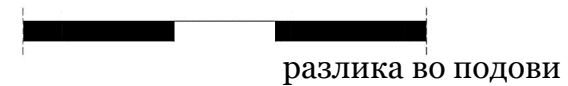
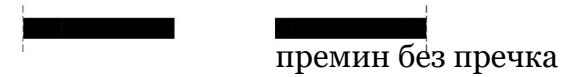

[M=1:100]

Видови на врати според начинот на отварање

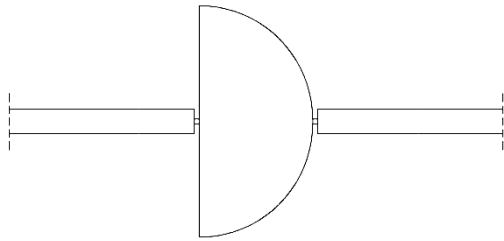
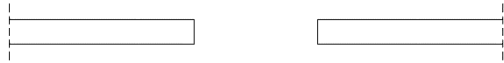
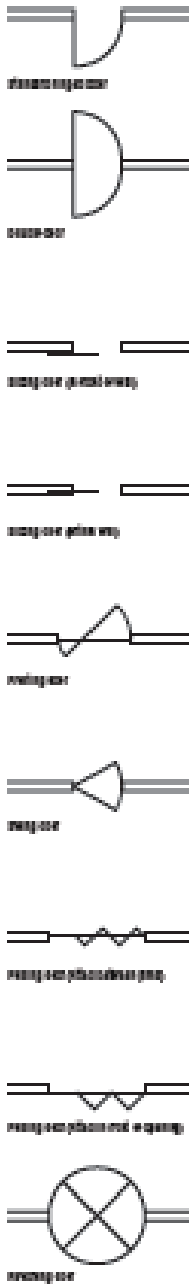

[M=1:50]

ОТВОРИ

ВРАТИ <

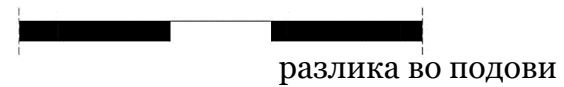
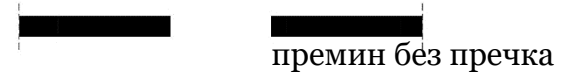

[M=1:100]

Видови на врати според начинот на отварање



ОТВОРИ ВО СИД - В Р А Т И

ОБЕЛЕЖУВАЊЕ НА НАДВОРЕШНА ВРАТА

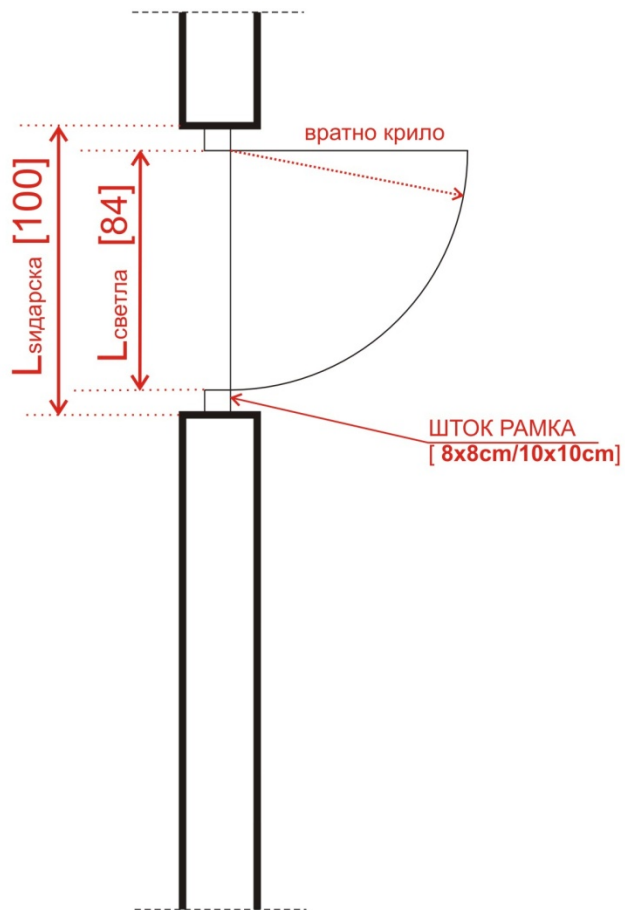

ОБЕЛЕЖУВАЊЕ НА ВНАТРЕШНА ВРАТА

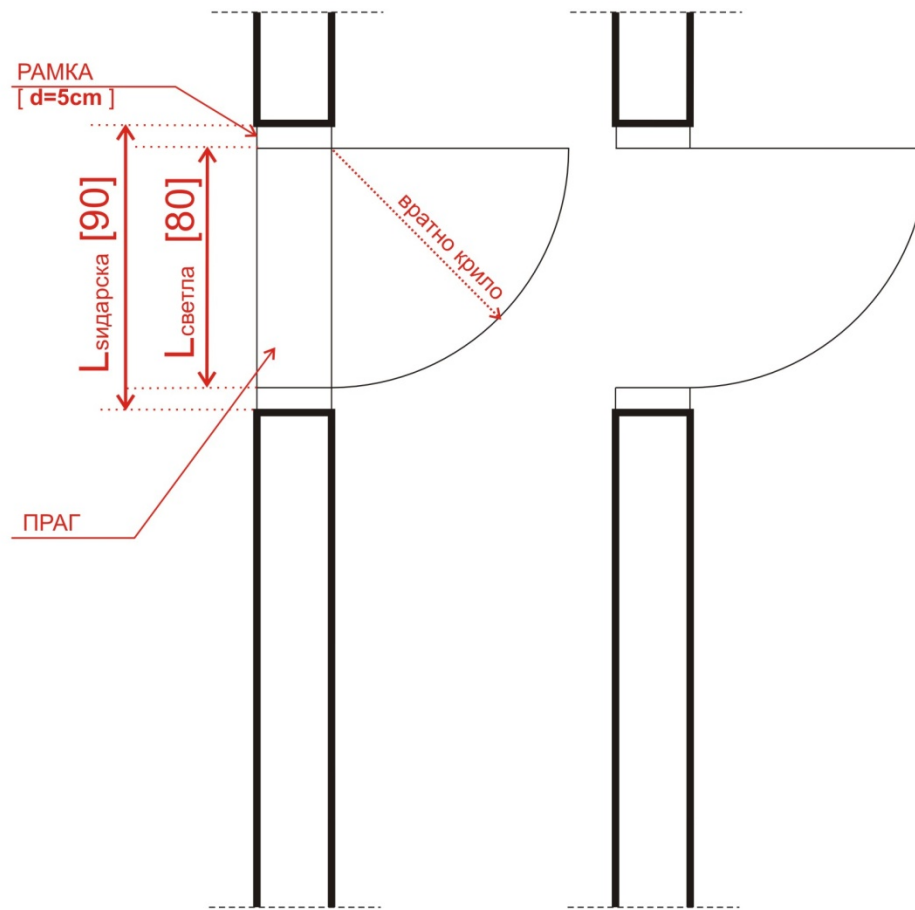

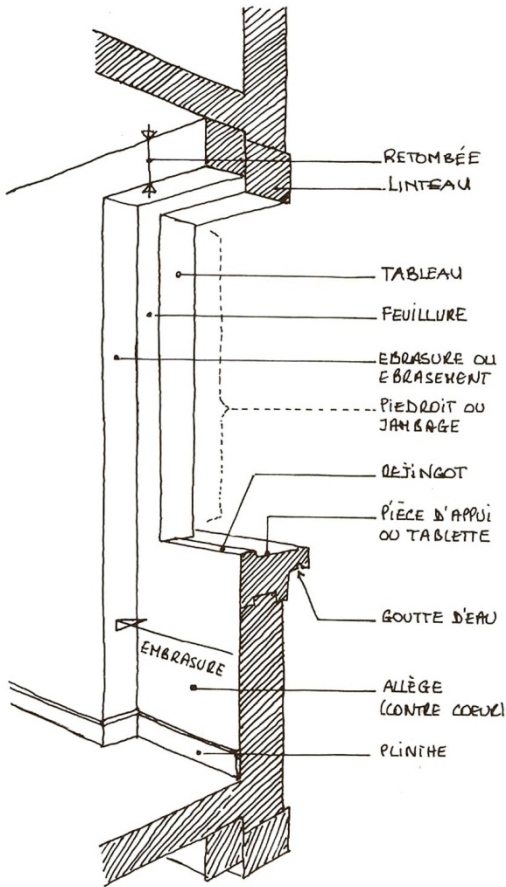

ОТВОРИ

ПРОЗОРСКИ ОТВОРИ <

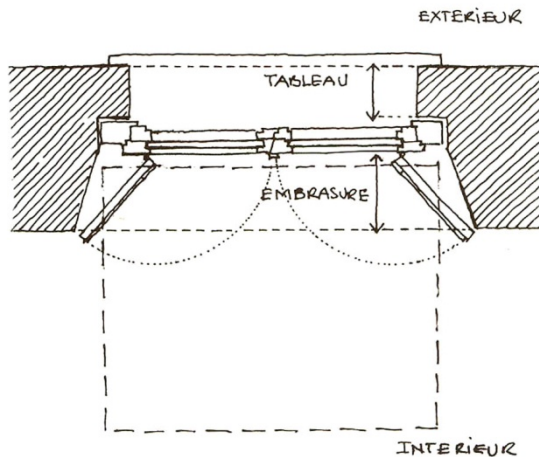

Основни елементи на прозорец:

- Рамка
- застаклување

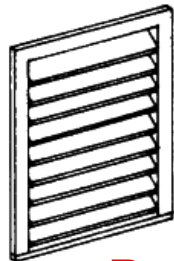
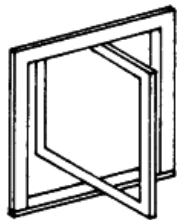
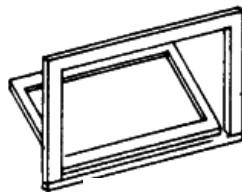
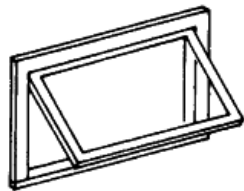
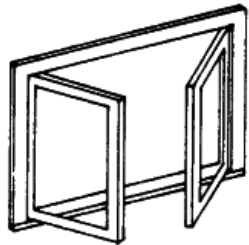
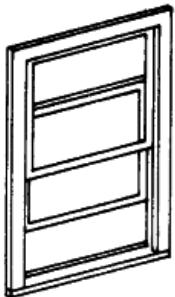
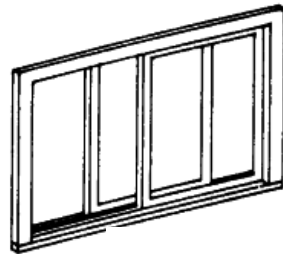
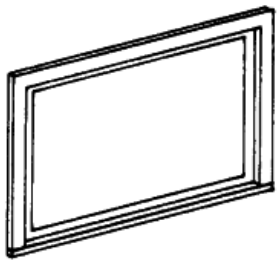

ОТВОРИ

ПРОЗОРСКИ ОТВОРИ <

Видови на прозори според начинот на отварање

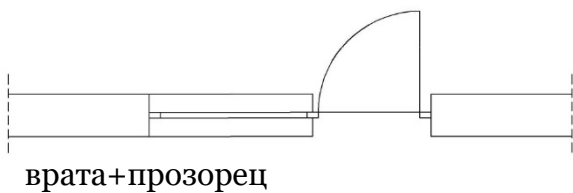
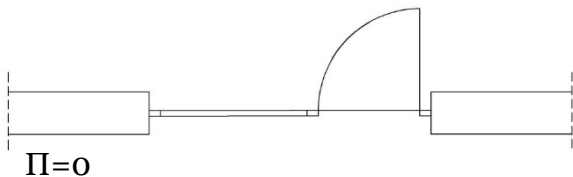
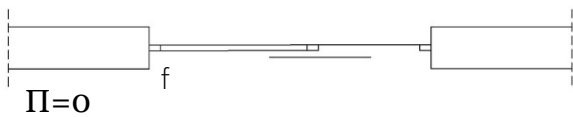

[M=1:50]

ОТВОРИ

ПРОЗОРСКИ ОТВОРИ <

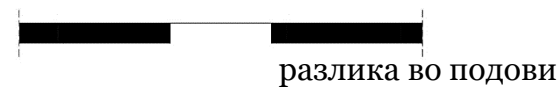
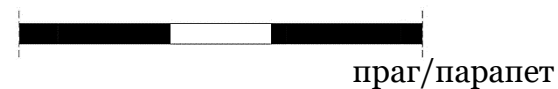

[M=1:100]